

# YBS Insulation

HIGH QUALITY PRODUCTS FOR THE BUILDING INDUSTRY

## Airtec

Aluminium Foil Bubble Insulation  
General Purpose Insulation

**Airtec-Single**

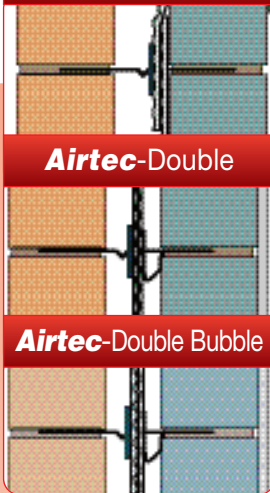

**Airtec-Double**

**Airtec-Double Bubble**

**Dry Lining  
Insulation System**

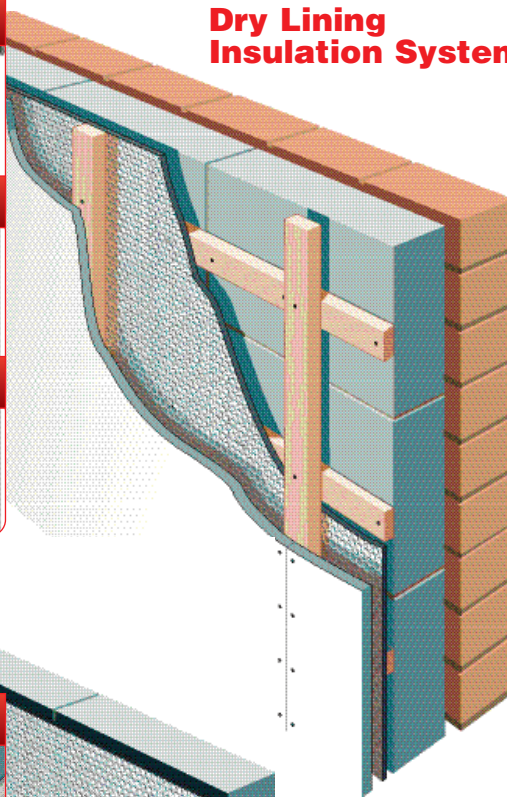

**Airtec-Single**

**Airtec-Double  
Airtec-Double Bubble**



**Cavity Wall  
Insulation System**

### Suspended Timber Floor Applications

Can be used with Floorboards or Tongue & Groove floor paneling

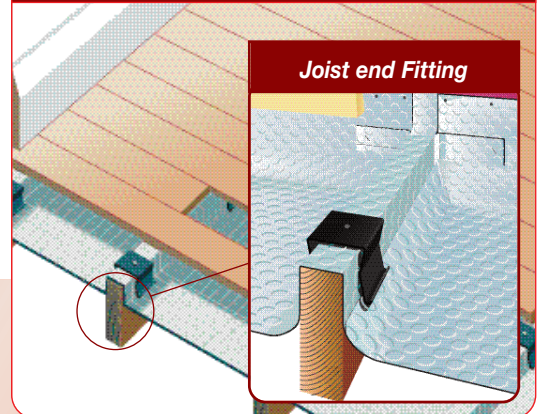

### Roof Insulation



Roof, Wall & Floor applications

2 in 1 Insulating Vapour Control

Able to achieve U-Values of 0.27

New Build & Refurbishment

CFC/HCFC Free



## General Purpose Insulation

### High Performance & Low Cost Insulation from YBS

**Airtec** is a multi-layer air bubble film insulation with aluminium bonded to either one face (**Airtec-Single**) or both faces (**Airtec-Double**). The aluminium is coated to give durability and corrosion resistance therefore creating a fully waterproof insulation system.

**Airtec** is a high performance insulation material which acts by trapping air within its structure creating low emissivity air spaces which enhance its total thermal capabilities.

**Airtec** is available with a fire retardant additive (**Airtec FR**). Please contact YBS Insulation on: 0844 991 0044 for further information.

**Airtec** is an ideal multipurpose insulation for improving the thermal performance of your building. Ensure you contact the YBS Insulation technical team for building regulations advice on

**Tel: 0871 917 0044\*** or e-mail **technical@ybsinsulation.com**

\*Calls are charged at 10p per minute from a UK BT landline. Other networks may vary.

## Airtec other applications

### Sheds and Garages

#### GREENHOUSE FIXING

Only fix to the lower half of the greenhouse, from floor level up on each wall, with the foil facing into the greenhouse.

Can be attached to the uprights of a timber greenhouse with corrosion resistant pins or with a staple gun positioned near the bottom, centre and top of the insulation.

Can be attached to an aluminium greenhouse frame with greenhouse clips, available from garden centres.



#### GARAGE DOOR FIXING

Simply secure with Foil Tape on to back of garage door, overlap by 75mm and secure with Foil Tape.



#### GARDEN SHED FIXING

Staple on to internal studs of garden shed and Foil Tape. For an internal finish please follow Wall Lining Installation instructions.



# Airtec in the Floor

## High Performance Insulation

### For Suspended Timber Floor Applications

**Airtec-Double** is a multi-layer foil bubble laminate, coated with polyethylene to provide a corrosion resistant insulation system.

**Airtec-Double** is a high-performance material which acts creating a low emissivity air space below the floor, thus reflecting the heat back.

**Airtec-Double** can be applied to enhance 'U' values in new build or refurbished building projects to meet and exceed current Building Regulations.

- **Airtec-Double** is rolled out over the joists
- **Airtec-Double** is then nailed in place through the Airtec Saddle Clips to maintain required air gap - 4 per m<sup>2</sup>
- The horizontal joints are overlapped by 100mm and are left open to allow any moisture accumulation to dissipate
- **Airtec-Double** must be brought up (behind the skirting board) to 75mm
- The decking is then fixed with screws (at 200mm centres) 37mm into the joist

### Joist End Fitting Recommendations

Make 2 x 75-100mm cuts in Airtec, same width as joists. Then make one further cut, same width again, on each side. Fold up flap (A), fold back Flaps (B) and pull Airtec (C) up to meet wall. Fix to wall and fit skirting board over, concealing Airtec.

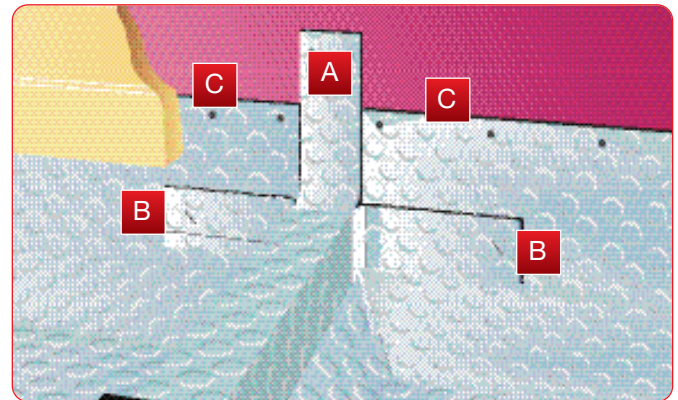

The heat loss in a floor is greater at the exposed perimeter edge of the floor. To calculate the U-Value, the exposed perimeter edge to area ratio needs to be worked out e.g. - a 100m<sup>2</sup> area, semi-detached house with 3 external walls of 10m each has a perimeter edge to area ratio of 0.3 (i.e. 30m ÷ 100m<sup>2</sup>=0.3). Overall thermal transmittance (U-Value) of suspended floors should be calculated using BS EN ISO 13370.

For full u-value advice please contact

YBS Insulations Technical Dept. on **0871 917 0044\***

\*Calls are charged at 10p per minute from a UK BT landline. Other networks may vary.

or by e-mail [technical@ybsinsulation.com](mailto:technical@ybsinsulation.com)

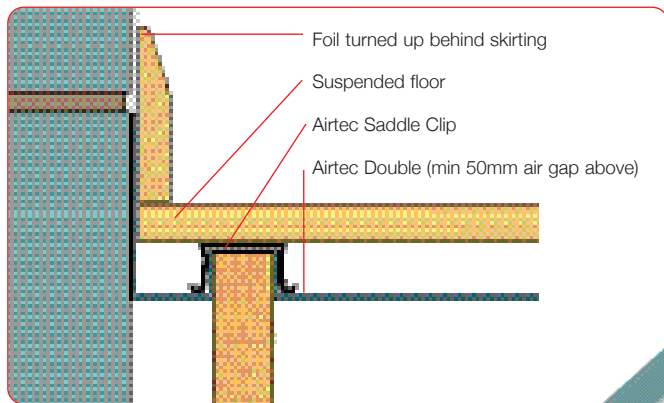

Minimum 50mm air gap above - achieved by use of Airtec Saddle Clips

Floor joists

Airtec Saddle Clip

Airtec Double

All joints must overlap by 100mm

**NOT TO BE TAPED**

### Technical Specifications/Properties

#### **Airtec-Single/Double**

Thermal Resistance	
Bubble	0.124m <sup>2</sup> K/W
50mm Cavity	1.372m <sup>2</sup> K/W
<b>Total Thermal Resistance</b>	<b>1.497m<sup>2</sup>K/W</b>
Environmental	CFC & HCFC Free
Dimensions	
<b>Thickness</b>	4mm
<b>Width</b>	1050mm/1200mm/1500mm
<b>Length</b>	25m roll

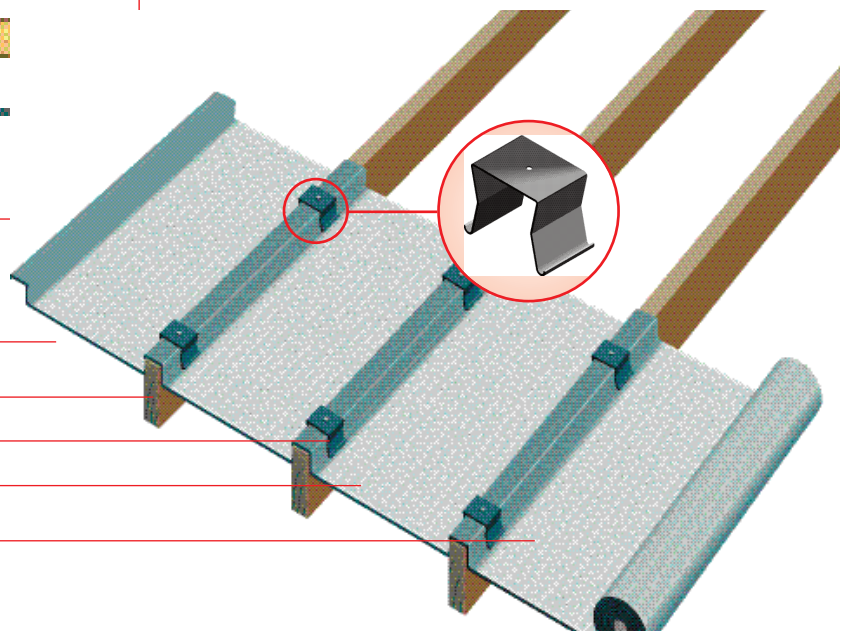

**Airtec** is an ideal multipurpose insulation for improving the thermal performance of your building. Ensure you contact the YBS Insulation technical team for building regulations advice on **0871 917 0044** (Calls are charged at 10p per minute from BT UK landline, other networks may vary)

or e-mail [technical@ybsinsulation.com](mailto:technical@ybsinsulation.com)



# Airtec in the Wall

## Cavity Wall Insulation System

Airtec can be used in one of two ways:

### FOR USE WITH THERMAL BLOCKS

**Airtec-Single** should be used in conjunction with thermal blocks. Airtec-Single is fixed to the inner leaf using special wall ties and YBS retaining Clips.

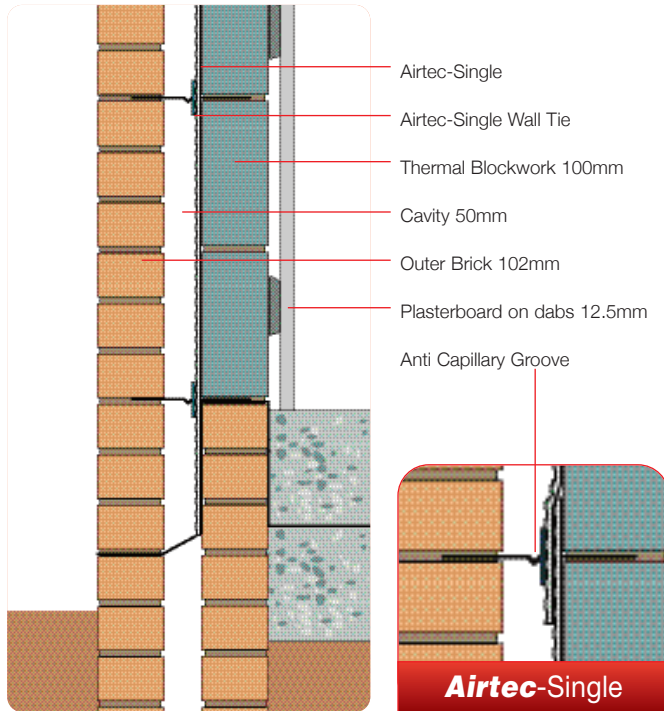

### FOR USE WITH ALL MEDIUM/DENSE BLOCKS

**Airtec-Double** should be used in conjunction with medium/dense blocks. Airtec-Double locates in the centre of the cavity using special wall ties and YBS retaining clips.

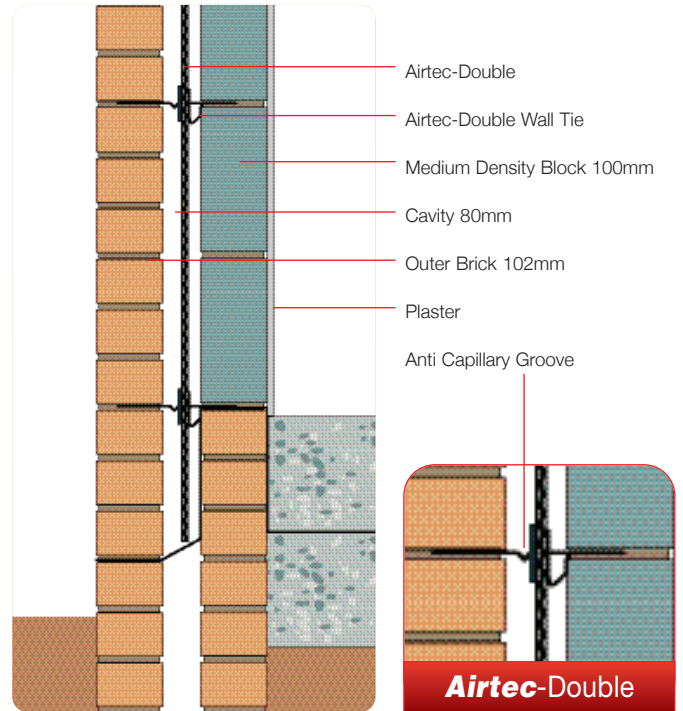

## Dry Lining Insulation System

### FOR USE WITH THERMAL BLOCKS

**Airtec-Single** should be used in conjunction with thermal blocks. Airtec-Single is rolled to 25mm x 38mm vertical counter battens, thus creating the required air gap of 25mm. Once Airtec-Single is in place and joints sealed using Airtec YBS 75mm tape, then plasterboard (internal finish) is applied directly onto the Airtec and fixed directly through to the battens.

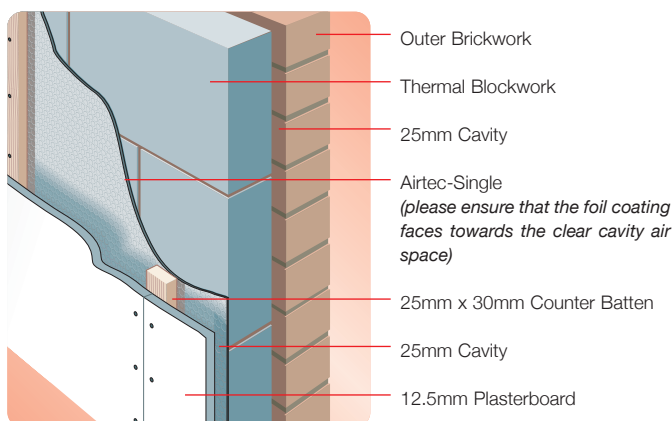

### FOR USE WITH ALL MEDIUM/DENSE BLOCKS

**Airtec-Double** should be used in conjunction with medium/dense blocks. Airtec-Double is fixed to the blockwork-mounted horizontal counter battens thus creating the required air gap of 25mm. Once Airtec-Double is in place and joints sealed with Airtec YBS 75mm tape, then the vertical counter battens are fixed at the required centres, ready for direct application of the plasterboard (internal surface).

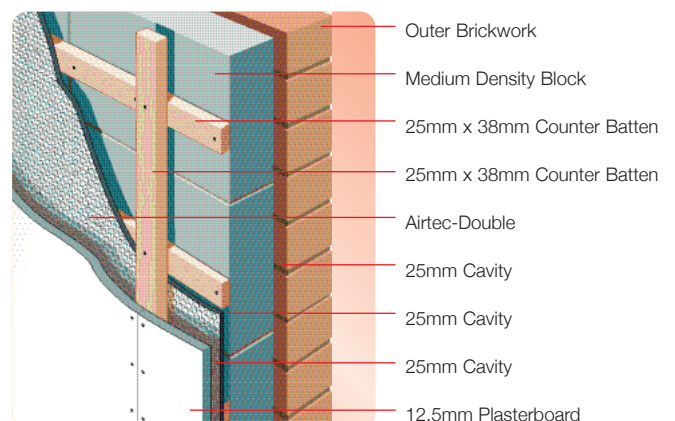

Please see next page for example u values



# Airtec Double "Double Bubble"

**Airtec Double Bubble** is a multi-layer double air bubble film insulation with aluminium bonded to both faces. The aluminium is coated with n.c. to give durability and corrosion resistance therefore creating a fully waterproof insulation system.

**Airtec** is a high performance insulation material which acts by trapping air within its structure creating low emissivity air spaces which enhance its total thermal capabilities.

## Airtec Double "Double Bubble" Wall

### Cavity Wall System

**FOR USE WITH ALL MEDIUM/DENSE BLOCKS**

**Airtec Double Bubble** should be used in conjunction with medium /dense blocks. Airtec-Double locates in the centre of the cavity using special wall ties and YBS retaining clips.

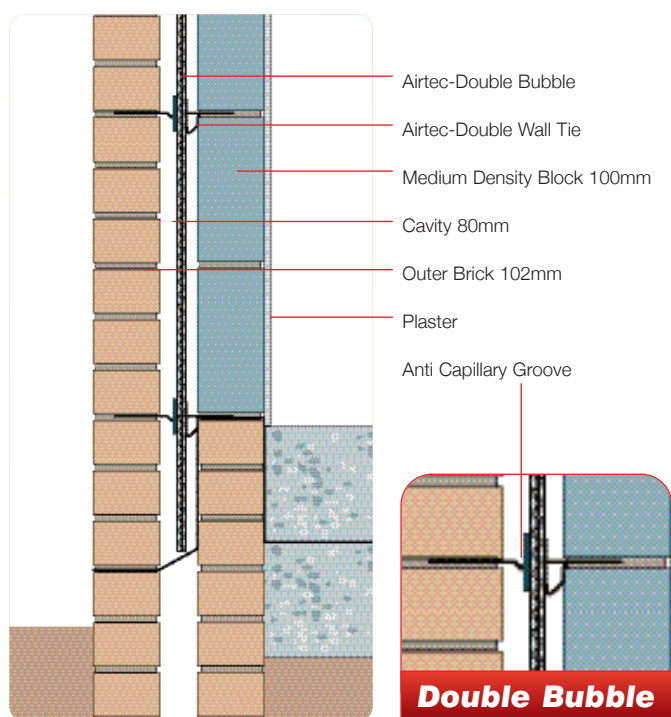

### Dry Lining System

**FOR USE WITH ALL MEDIUM/DENSE BLOCKS**

**Airtec Double Bubble** should be used in conjunction with medium /dense blocks. Airtec-Double is fixed to the blockwork-mounted horizontal counter battens thus creating the required air gap of 25mm. Once **Airtec Double Bubble** is in place and joints sealed with Airtec YBS 75mm tape, then the vertical counter battens are fixed at the required centres, ready for direct application of the plasterboard (internal surface).

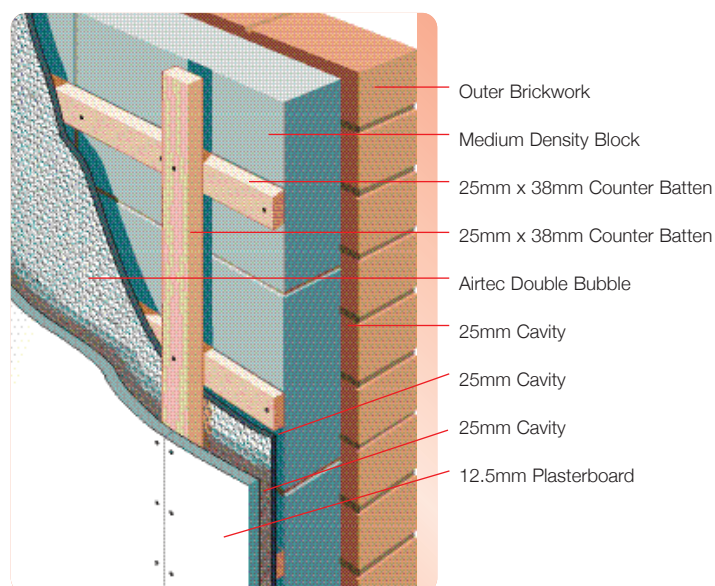

## Double Bubble Examples of 'U' Value Calculation

U-VALUE TO 0.35			
	Thickness (mm)	Thermal Conductivity (W/mK)	Thermal Resistance (m <sup>2</sup> K/W)
Outside surface resistance	-	-	0.040
Brick, External	102.50	0.770	0.133
<i>bridged by 17.2% Mortar (102.5mm)</i>			
Airtec Double Bubble Cavity	50.00	-	0.665
Airtec Double Bubble	7.00	-	0.173
Airtec Double Bubble Cavity	25.00	-	0.665
Lightweight Block (thin joint system)	100.00	0.110	0.909
<i>bridged by 1.2% Mortar (100.0mm)</i>			
Plaster Dabs	15.00	-	0.170
<i>bridged by 20.0% Plaster Dabs (15mm)</i>			
Plasterboard	12.50	0.190	0.066
Inside surface resistance	-	-	0.130
U-value, Combined Method: <b>0.35W/m<sup>2</sup>K</b>			

U-VALUE TO BELOW 0.27			
	Thickness (mm)	Thermal Conductivity (W/mK)	Thermal Resistance (m <sup>2</sup> K/W)
Outside surface resistance	-	-	0.060
Brick, External	102.50	0.770	0.133
<i>bridged by 17.2% Mortar (102.5mm)</i>			
Cavity	50.00	-	0.665
Airtec Double Bubble	7.00	-	0.173
Cavity	50.00	-	0.665
Lightweight Aerated Aggregate Blocks	100.00	0.190	0.526
<i>bridged by 6.7% Mortar (100.0mm)</i>			
Battens	20.00	-	0.665
<i>bridged by 8.3% Timber (25.0mm)</i>			
Airtec Double Bubble	7.00	-	0.173
Battens	20.00	-	0.665
<i>bridged by 8.3% Timber (25.0mm)</i>			
Plasterboard	12.50	0.190	0.066
Inside surface resistance	-	-	0.120
U-value, Combined Method: <b>0.27W/m<sup>2</sup>K</b>			



# Airtec Double "Double Bubble" Roof

## Easy fit Loft Insulation without the thickness

Airtec works by reflecting radiant heat much like light hitting a mirror. This gives a warmer, money saving environment.

- Boost your loft to an equivalent of 40mm polystyrene in a 7mm layer.
- Lightweight & flexible.
- Keeps your house warmer in winter.
- Keeps your house cooler in summer.
- Airtec is an ideal radiant barrier to supplement the insulation already in the loft.



## installation

- Check the area you are insulating and make any needed repairs before installing Airtec.
- Unroll the Airtec as you work, and cut it to suitable lengths with scissors or utility knife.
- Staple the Airtec to the underside of exposed rafters or between the rafters, ensuring a ventilation gap of at least 50mm above the Airtec.
- Tape the joints of the Airtec to give a vapour seal and increase the thermal value of the Airtec.
- If you wish to board out the roof please ensure a gap of 25mm to the underside of the Airtec before boarding.
- See diagrams below for fitting options and roof coverage:

**Zero  
GWP**  
**Global  
Warming  
Potential**

**Zero  
ODP**  
**Ozone  
Depleting  
potential**

## Application

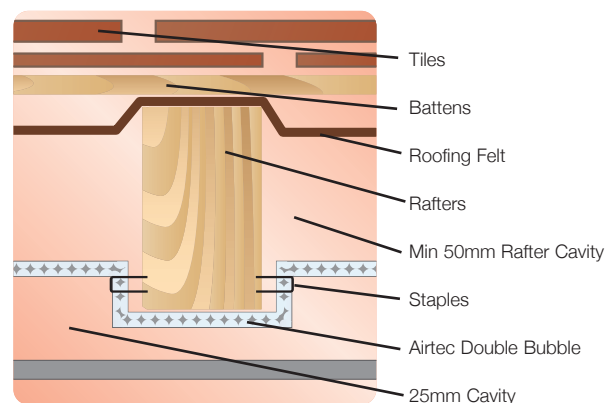
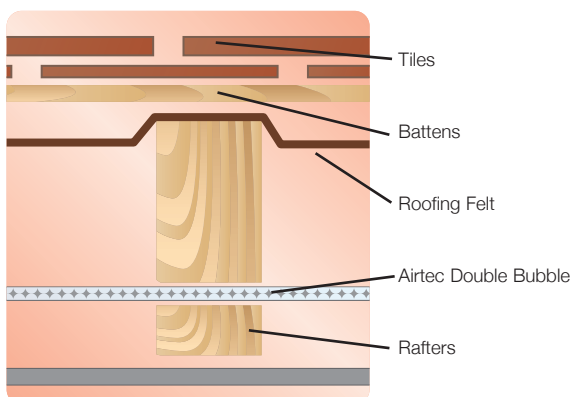

# Drawings

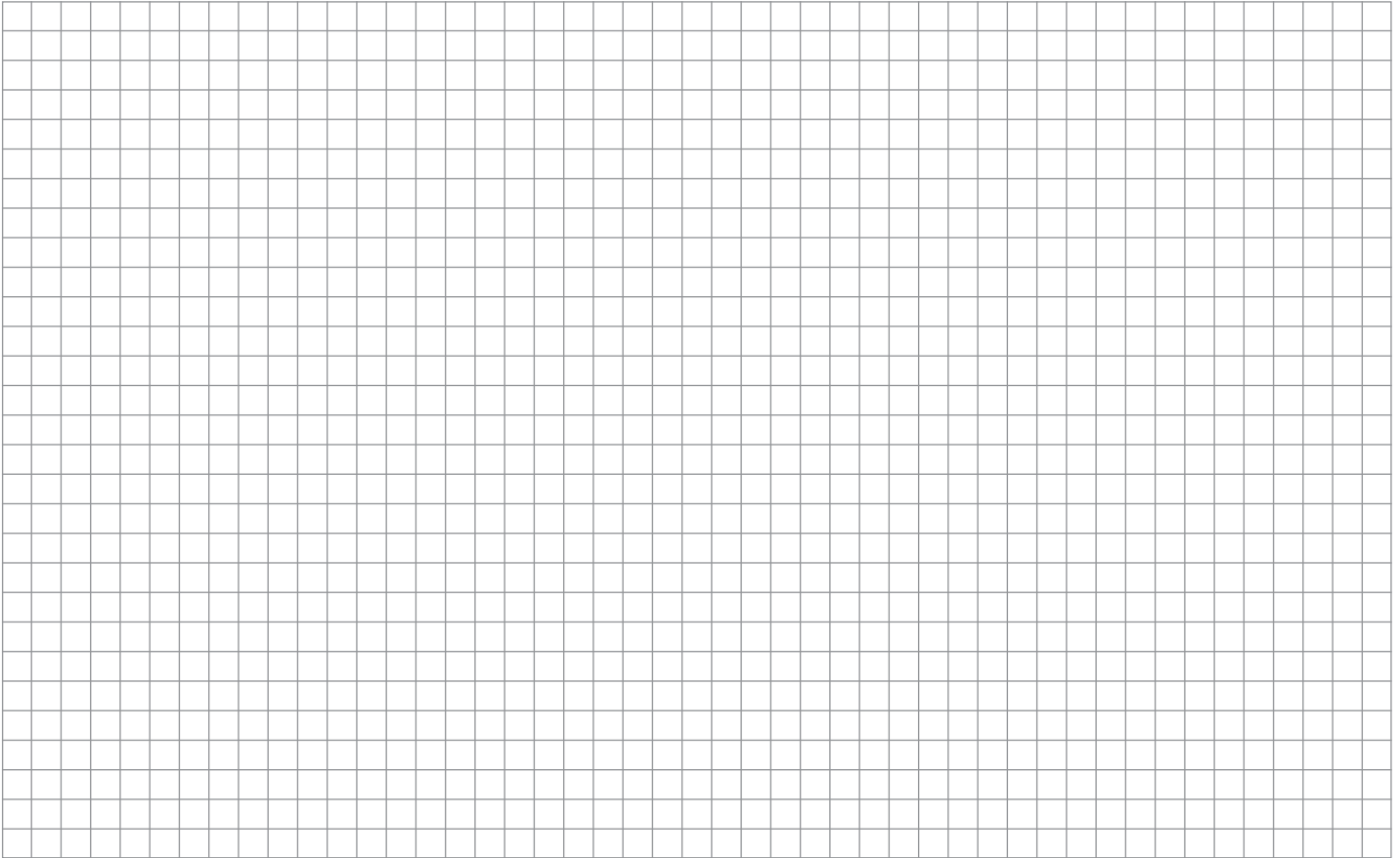

## AIRTEC - TECHNICAL SPECIFICATION/PROPERTIES

	<b>Airtec-Single</b>	<b>Airtec-Double</b>	<b>Airtec-Double Bubble</b>
<b>Thermal Resistance</b>			
<b>Bubble</b>	0.124m <sup>2</sup> K/W	0.124m <sup>2</sup> K/W	0.170m <sup>2</sup> K/W
<b>Cavity</b>	0.665m <sup>2</sup> K/W	0.665m <sup>2</sup> K/W	0.665m <sup>2</sup> K/W
<b>Total Thermal Resistance</b>	<b>0.789m<sup>2</sup>K/W</b>	<b>1.454m<sup>2</sup>K/W</b>	<b>1.500m<sup>2</sup>K/W</b>
<b>Environmental</b>	CFC & HCFC Free	CFC & HCFC Free	CFC & HCFC Free
<b>Dimensions</b>			
<b>Thickness</b>	4mm	4mm	7mm
<b>Width</b>	1050mm/1200mm/1500mm	1050mm/1200mm/1500mm	1050mm/1200mm/1500mm
<b>Length</b>	25 / 50 / 100 / 200M roll	25 / 50 / 100 / 200M roll	25 / 50M roll
<b>Airtec Foil Tape</b>	50m x 75mm (24 rolls per box)		

## CONDENSATION RISK

Further to calculating the thermal insulation requirements through a cavity wall, a check should be made for predicting the risk of condensation within the structure. This should be carried out using the method described in BS5250:1999.

### TECHNICAL REFERENCES

- Building Regulations 2000 (2006 edition) Approved Documents L1A, L1B & L2A, L2B.
- Building Standards Part J Sept. 2001
- BRE publication 'Thermal Insulation: Avoiding the risks'.
- BS EN ISO 6946 : 1997 Building components and building elements - Thermal resistance and thermal transmittance - Calculation method.
- British Standard References: BS 5250 Control of Condensation in Buildings.

### TESTED

- Emissivity measured by National Physical Laboratory.
- Thermal resistance measured by Independent Test Laboratories.
- Tested to BS EN 12153:2000 for water tightness and air permeability.
- Manufactured in the UK and meeting the requirements of BS EN ISO 9002.

